

87500624

LC

Tridonic, LC 42W 700/900/1050mA flexC SR ADV, LED Converter Compact ADVANCE, Made In PRC, 5yrs Warranty



DATA SHEET

MARKETING INFORMATION

Brief Description 42W 700/900/1050mA flexC SR ADV Constant Current LED Driver

PHYSICAL CHARACTERISTICS

Colour Finish White

MECHANICAL SPECIFICATION

Item Nett Weight (kg) 0.18kg
 Length (mm) 160mm
 Width (mm) 82mm
 Height (mm) 34mm

ENERGY SPECIFICATION

Energy Class A++ to A

ELECTRICAL & SAFETY SPECIFICATION

Protection Class Class 2 - Double Insulated
 Dimmable No
 IP Rating IP20

QUALITY STANDARDS

Average Life (hrs) 50000hrs
 Warranty (yrs) 5yrs

LINE DRAWING

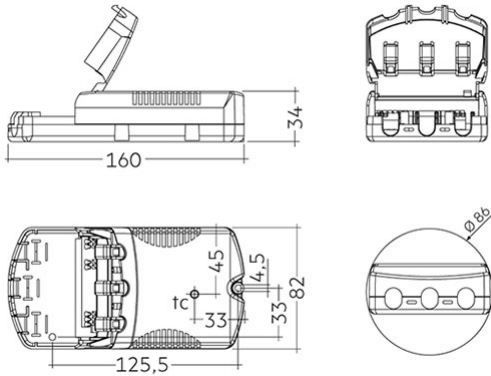

[Click to view the full product details](#)

OVERVIEW

Independent constant current LED Driver, Adjustable output current between 350 and 500 mA, High efficiency, For luminaires of protection class I and protection class II, For luminaires with M and MM as per EN 60598, VDE 0710 and VDE 0711, Temperature protection as per EN 61347-2-13 C5e. Long life.

Inspired Lighting Ltd. are continually developing and improving their products. Technical specifications subject to change without prior notice.